

SENSITIVITY AS AN ASSESSMENT CRITERION FOR PRODUCT SPECTRA

Maik Maurer, Udo Lindemann

Keywords: product structure, product spectrum, probabilistic reasoning, production systems

1 Introduction

The application of the influence matrix as method for design planning is often used to guarantee product's quality and reliability in early design phases. Thus, critical elements, which e.g. strongly influence or become influenced by other elements, can be identified by analyzing interdependency networks. Unfortunately, the application of this proceeding in the context of product spectrum analysis is not possible so far. This results from the extensive character of a product spectrum (in contrast to an invariant product), which does not only possess static interdependencies, but general possibilities of element linking. A product spectrum describes a multitude of possible product specifications on an abstract level. In addition, uncertainty must be handled regarding the occurrence of elements and interdependencies. The presented approach introduces the assessment of a new criterion of sensitivity as an extension of criteria, which are commonly used for analyses by static influence matrices. The new sensitivity criterion permits the identification of important elements in a product spectrum and elaborating useful measures for its further development.

2 From invariant product structures to product spectra

Methods exist for intensive consideration of invariant products, which allow identifying the characteristics of product's elements. The values of active sum, passive sum, activity and criticality of elements are commonly used [1, 2]. The active sum of an element represents its quantity of outgoing dependencies and provides a measure for expected impact on the entire product, due to the element's own adaptation. If elements with high active sums must be modified concerning their properties, this will result in numerous requests of adaptation to further product components. In contrast to that, the passive sum of an element describes its extend of impact, which is induced from other elements. The activity is computed by multiplication of active and passive sum of an element, whereas division of both values defines the criticality. Particularly, the criticality represents an important measure for characterizing product elements. It combines in one single value the element's relevance to chance impact, which is initiated by adaptation of the mentioned element itself. Figure 1 illustrates a simple product model consisting of three elements and three connecting dependencies. Furthermore, the belonging influence matrix and the influence diagram (containing exemplary constant lines of activity and criticality) [2] are shown in the picture. It is obvious that element B possesses the highest value of criticality, as an adaptation of this element involves considerations of an active as well as two passive dependencies.

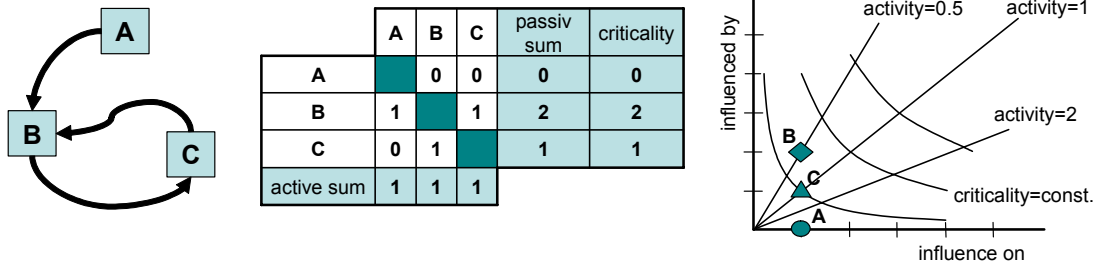

Figure 1. Criticality as criterion for invariant products

This possibility of analysis is designed for its application to invariant structures, because the calculation base are distinctly defined dependencies between elements. This method cannot be directly transferred to structure analysis of products, which are not completely defined in all specifications. Yet such products are predefined at a rather abstract level of detail, which describes a multitude of feasible products. One possibility of method transfer is shown exemplarily in figure 2. For every known product variant the values of criticality are acquired separately. Subsequently, for every product element the entirety of resulting criticality values can be evaluated statistically. The influence diagram of figure 2 displays the resulting “clouds of criticality”, which represent the range of dispersion of an element’s criticality values. Elements with a large range of dispersion or huge discrepancy in criticality values could be relevant for further consideration. Moreover, an element with rather identical criticality values in all concerned product variants can be assumed as constant factor of the abstract product structure.

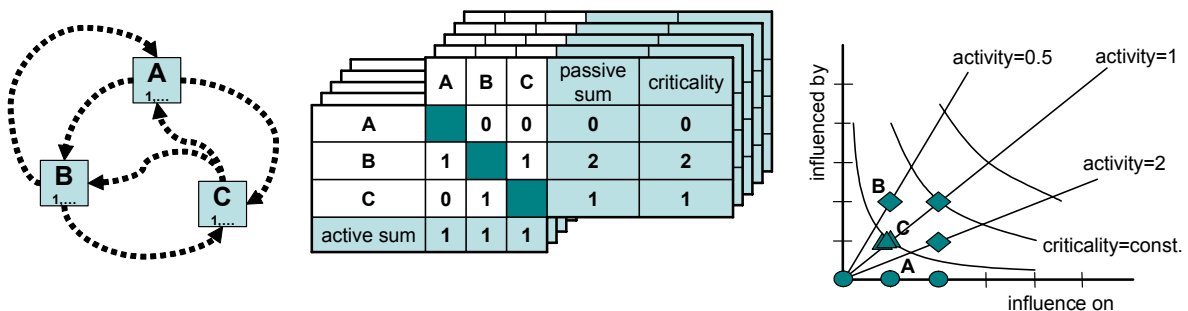

Figure 2. Criticality applied to variant rich products

However, this approach is not promising, as comprehensive product structures require an extensive amount of data, which must be acquired. Furthermore, in this approach the statistic criticality value is determined only by existing product variants, which represent mutually independent specifications. Thus, no reliable prediction can be determined describing the criticality for elements in a new product variant. Criticality values of single product specifications can deviate considerably from statistically computed values, especially if the calculation base of known variants does not comprise a large quantity of products. The same effort of dependency acquisition must be practiced for identifying every variant’s criticality values. However, effective analysis of abstract product structures is required to provide possibilities of early design evaluation [3], before customer induced specifications are executed.

3 The sensitivity criterion

As a first step, product spectra and their components must be defined in order to allow definition of a suitable assessment criterion. Thus, a model is established, which focuses on the specification of element dependencies. Based on this, the design of dependency networks by means of a production system [4] and adapted calculation rules for probability computing is explained. Ultimately, such dependency networks provide the basis for determination of sensitivity values [5] as suitable assessment criterion for the analysis of product spectra.

3.1 Areas of a product spectrum

Up to now, abstract product structures have been mentioned, which possess degrees of freedom and allow deriving specified product variants from them. In the following, these product structures are named “product spectrum”, which comprehends the entirety of all possible product specifications. On the one hand, components like fixed or optional parts can serve for the description of a product spectrum [6, 7]. On the other hand, the distinction by means of existing dependency types is more convenient for subsequent considerations.

This context is explained in the figures 3 and 4. The displayed inclusion area of a product spectrum describes its positive dependencies, e.g. “element x has impact on element y”. In contrast to that, the exclusion describes the explicitly ascertainable statements about non-existing dependencies between elements of the product spectrum. This would be for instance “element x never possess any impact on element y”. The existence of dependencies can depend on further conditions describing the product logic of the spectrum. Inclusion and exclusion area together build the explicit core of a product spectrum description. In the succession area, dependencies are not explicitly determined, but result from combining existent dependencies. Particularly, the succession area is of major importance for product spectrum analyses, because here resulting constellations are typically unknown or only implicitly known to product designers. An example of dependencies in the succession area is illustrated in figure 4.

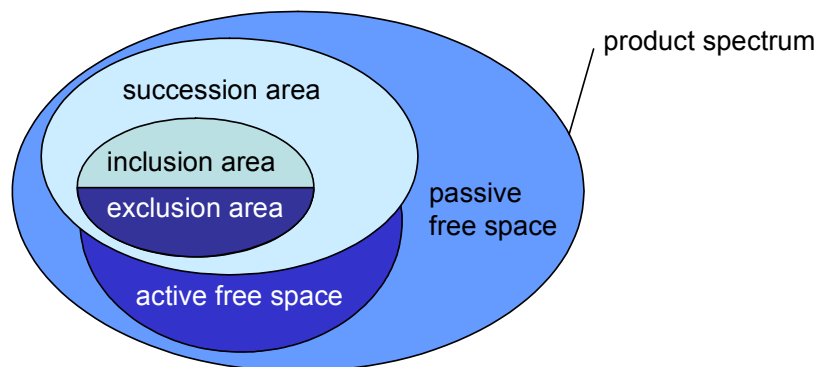

Figure 3. Classification of areas in product spectra

The definition of product spectra by inclusion, exclusion, and succession area is completed by a free space, which is separated in active and passive free space. In the active free space, those elements are located, which affect the product spectrum actively. E.g. in case of a car seat spectrum, this could be the length of the leg of a passenger or his weight. As elements of the active free space possess direct impact to the product spectrum (in the example a specification of a product variant could be derived from information obtained from free space), it is useful to consider these elements together with the main product elements. This corresponds methodically to an enhancement of system borders [8, 9].

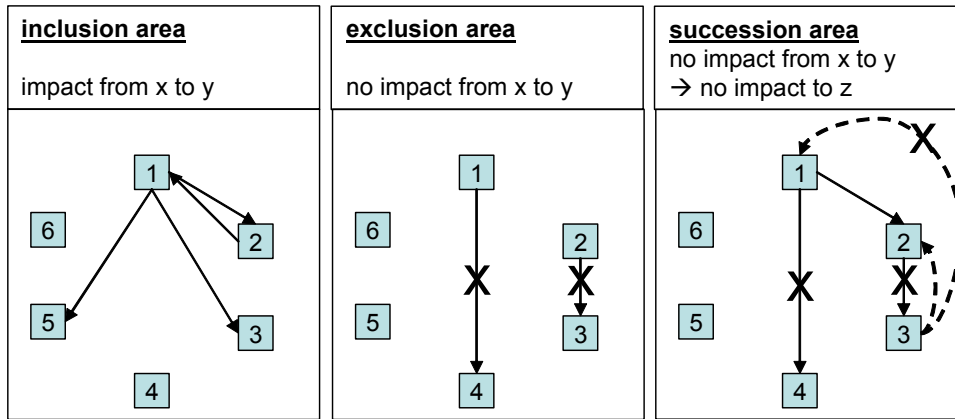

Figure 4. Areas of product spectra, specified by dependencies

The passive free space contains elements, which are affected directly by adaptations in the product spectrum. Once again, this represents an enhancement of the system borders. In passive free space important interfaces of the concerned product are observed. Thus, probable impact to nearby products can be determined reliably. E.g., a specification of the car seat product spectrum could probably ask for modifying the seat slide, in order to meet the requirements of a higher passenger weight (induced from active free space). As this slide is no integral component of the seat, it cannot be located in the inclusion or exclusion area of the product spectrum. However, the seat slide representation in passive free space can lead to important information output, due to product spectrum adaptations.

3.2 Design of a production system

The presented approach bases on acquisition of available product structures in form of a production system [10, 11]. This construction permits the subsequent definition of an assessment criterion for product spectra. The procedure of production system design is shown in figure 5 by means of a simple example consisting of a three-element product spectrum. Each element possesses its probability of existence referred to specified products. I.e., a probability of existence of 0.8 means that with a probability of 80%, this element will occur in specified product variants. In practical application the values can be estimated by experts in order to enable production system design. However, quality of data will increase, if the values of probability can be derived from available product data (e.g. from distribution).

The dependencies between elements in the production system are generated by rules. One simple (inclusion) dependency between element A and B is expressed by the rule: “if A exists and B exists, then the dependency between them exists too”. Other rules can express exclusion dependencies or define basic constraints of the entire product spectrum. In addition, rules integrate a value for the probability of existence of dependencies. This value is determined similarly to the probability of elements – in best case it is derived from available product data.

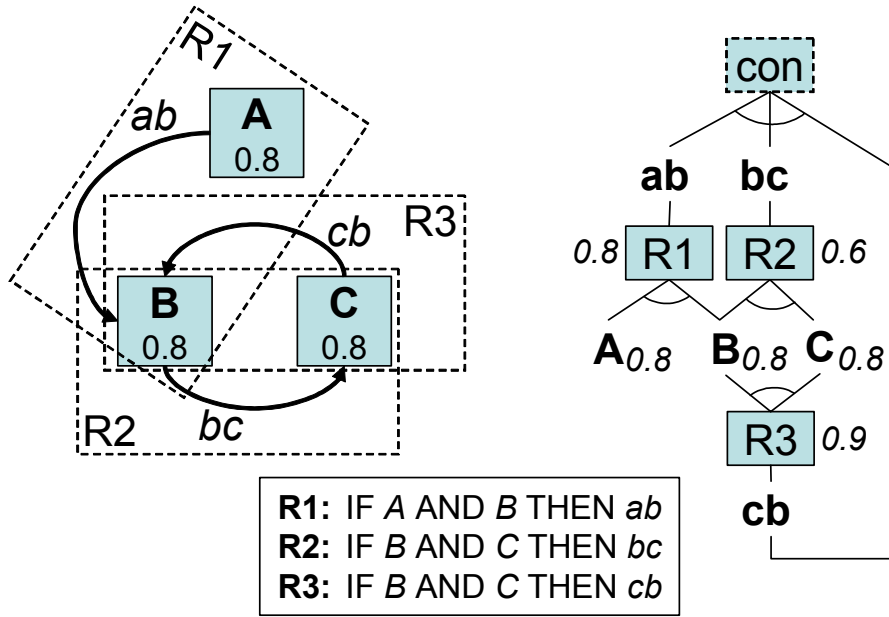

Figure 5. Creation of an exemplary production system

The production system on the right side in figure 5 represents exactly the structure constellation shown on the left side. Now it is possible to determine a probability of the entire constellation by means of known probabilities of elements and dependencies. Mostly the single probability values include uncertainty, which increases in common calculation processes for composed probability values. Thus, a simplified procedure is applied, which differs from the mathematical correct one. The reason is the uncertainty of the input data. As no higher accuracy can be generated from this, no mathematical formulation of the problem is needed. The chosen procedure has shown already its suitability in practical applications [10]. The probability of a constellation consisting of two elements, which are connected by one dependency, is computed as follows:

$$P_{total} = \min\{P_X; P_Y\} * P_R \quad (1)$$

A decisive advantage of this calculation is its simplicity. Furthermore, this procedure represents a worst-case consideration, as it can be seen in the later explained definition of the assessment criterion. The determination of the probability of existence of the exemplary constellation in figure 5 follows as:

$$P_{total} = \min\{\min\{P_A; P_B\} * P_{R1}; \min\{P_B; P_C\} * P_{R2}; \min\{P_B; P_C\} * P_{R3}\} * P_{con} \quad (2)$$

The computed total value of probability of existence does not possess any relevance in terms of an absolute value. In fact, it serves as reference point for the determination of probable impact on involved elements. If element modifications are executed, the deviation of this total value of probability is a significant indicator for concerned elements. The sensitivity values provide possibilities of rating elements relatively to each other.

3.3 Local sensitivity

Based on the structural modeling in production systems explained above, it can be determined, how far the probability of existence of one element can vary, without causing changes to the probability of existence of a specific structure constellation. A simple example is the increasing probability that customers request leather covers for their car seats. In this

case, interesting information for the manufacturer would be if such adaptations (increasing quantity of specified seats with leather covers) cause necessary modifications to the entire product spectrum. This question leads directly to the following definition of the local sensitivity: The local sensitivity of an element describes the ratio of its actual probability of existence to the variability of this probability without impact to the considered product spectrum constellation.

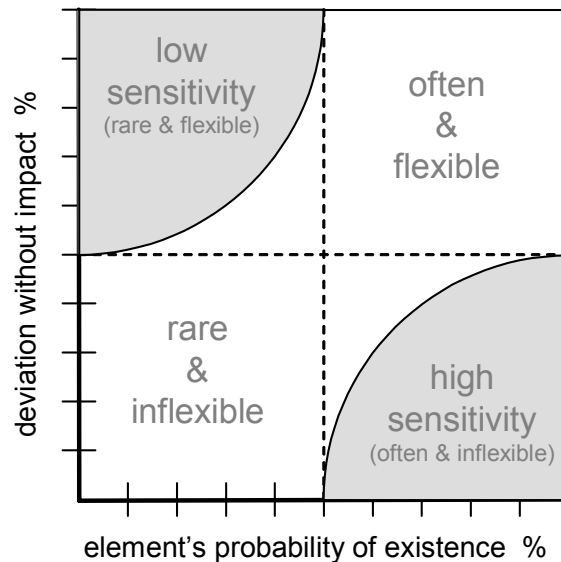

Figure 6. The diagram of element's local sensitivity

Thus, the sensitivity bases on nominal values, which can be specified. Therefore, it is suitable for its illustration in form of a diagram. Figure 6 displays such a diagram providing directly the essential significance of the local sensitivity criterion. A high value of local sensitivity is applied to elements of the product spectrum, which appear in product specifications with high probability. Moreover, these elements cause impact on further product components or the entire product spectrum already when little changes of their probability of existence occur. In contrast to that, elements with a low sensitivity value will rarely appear in specified products and permit a large deviation of their probability of existence without further impact to the constellation. The required values of probability of existence (of elements and dependencies) must be estimated by experts or derived from available product data. The possible deviation of the probability of existence, without impact to the product constellation is simple to be determined by means of the production system and effective computer support. If results of sensitivity determination are entered in the diagram of figure 5 for all elements, product designers can directly identify the elements, which require further consideration.

3.4 Global sensitivity

The criterion of local sensitivity is suitable for characterizing elements when specific constellations must be considered in product spectra. However, a global examination of product spectra can be useful as well. Such global analysis cannot be handled with the criterion of local sensitivity, because already small product spectra possess extremely high quantities of possible constellations. As the local sensitivity bases on one specific constellation, considerations of the entire product spectrum would result in enormous and even unmanageable data. Thus, the criterion of global sensitivity is introduced, which can be derived from the following question: How much does the mediated probability of existence of (all or selected) constellations vary, due to a change of the probability of existence of one specific element? Now the global sensitivity is defined as follows: The global sensitivity of an

element is determined by the mediated deviation of the probability of existence of all concerned constellations, due to the modification of the element's own probability of existence. The procedure for computational determination of global sensitivity values is displayed in figure 7.

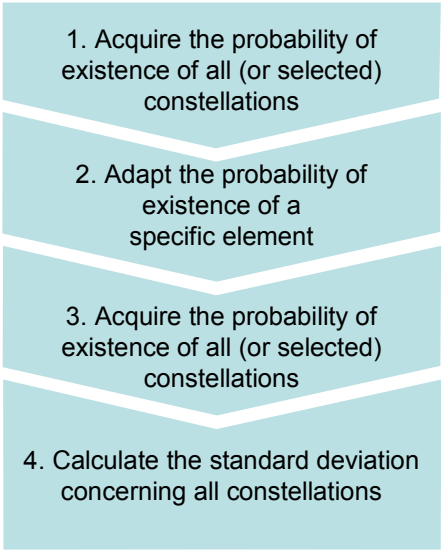

Figure 7. Determination of global sensitivity

First, the probability of existence of all concerned constellations is determined by means of the production system approach. In the following, the element, which is to be considered more closely, is modified in its own probability of existence. Subsequently the first step is executed again. Ultimately, the standard deviation is computed on the probability of existence of all concerned constellations. The result can e.g. be displayed in simple diagram form, as it will be explained in the case study in chapter 4. Similar to values of local sensitivity, global sensitivity values cannot be taken as absolute values, the relevance results from their mutually comparing. Especially in case of comprehensive product spectra, the computation of global sensitivity is closely connected to effective handling of complex data. Thus, effective software support is required imperatively. Moreover, the structural correlations, for instance exclusion or further constraints, must be used in order to reduce calculation effort.

4 Case study

The practical application of the sensitivity criterion is executed in the following with the exemplary case study of a car seat. Six elements were chosen from the comprehensive product spectrum for further explanations. The use case for the local sensitivity criterion is the constellation characterized by three dependencies displayed in figure 8. The leather cover of the seat has impact on the seat ventilation, the seat heater influences the leather cover, and the memory function affects the electric seat adjustment. The functionality of crash positioning (upright seat positioning in case of accidents) does not appear in the concerned constellation and does not dispose of any dependencies in it. The light grey lines in the spectrum in figure 8 highlight the possible dependencies of the spectrum (without further specifications of dependency types, e.g. exclusion). The elements as well as the dependencies possess a probability of existence, which has been estimated by experts of the manufacturer.

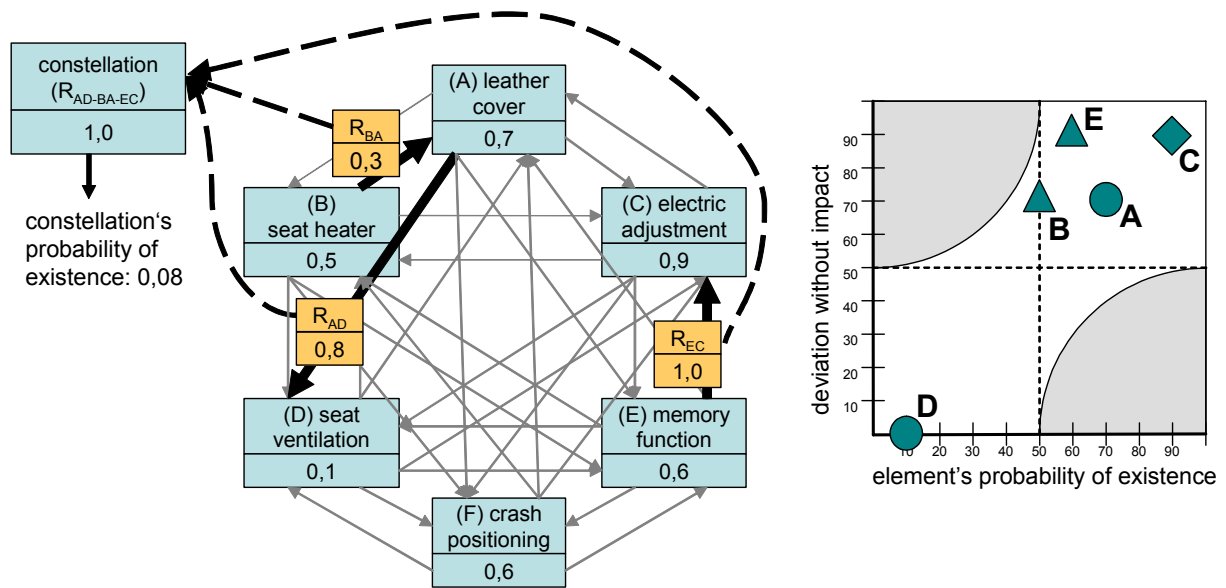

Figure 8. Determination of local sensitivity for elements of a car seat

Now the question must be answered, which elements possess significant impact on the product spectrum constellation in case of their modification. A distinct expectation could be that due to actual fashion the requests of leather covers will increase. By means of the local sensitivity criterion it must be determined if elements of the actual constellation (in particular the leather cover) will lead to considerable impact on the product spectrum in case of modification. At this point the difference to the commonly used criterion of criticality can be seen. While local sensitivity concerns a unspecified product spectrum, criticality can only be applied to one invariant product – in the case study one single seat specification without degrees of freedom.

The result of local sensitivity determination for the case study is illustrated for all elements in figure 8 at the right side. It is obvious that no elements possess extremely high or low sensitivity values. However, differences between elements can be seen, which may lead to case specific measures. The most significant element is the seat ventilation possessing immediate impact on the product spectrum when modifying its probability of existence. Nevertheless, the sensitivity value is not rated very high, because seat ventilations are rarely applied to specific product variants. Thus, it can be concluded that seat ventilation is not to be considered closer due to its low probability of existence. Simultaneously it must be kept in mind that this element becomes important, when customer requests increase (e.g. due to marketing strategies of the manufacturer). In similar ways, the expected increase of leather cover requests can be assessed. Actually, the element possesses an average value of local sensitivity. However, the increase of customer requests (and with this the increase in probability of existence) would push the element in the area of highest sensitivity values. In order to prevent a too strong impact on the entire product spectrum, useful measures must be initiated simultaneously, with beginning increase.

In addition to considerations on one specific constellation, a global sensitivity analysis is executed for the exemplary case study. According to the procedure presented in chapter 3.4, the global sensitivity is determined for relevant constellations only. Fixed values of 20% and 50% for the positive as well as negative deviation of probability of existence have been chosen, in order to provide comparability between the involved elements. The results are displayed in figure 9. It can be seen that the increase of the probability of existence of the seat ventilation causes large impact to the product spectrum.

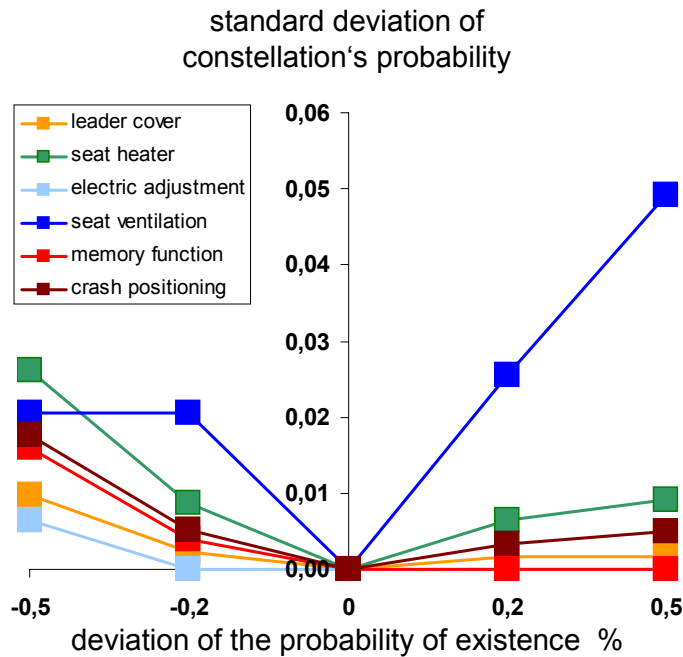

Figure 9. Global sensitivity for elements of a car seat

It is important for evaluation of global sensitivity analysis that computed values can only be used for relative considerations – they do not possess any absolute significance. Moreover, this simple model of product spectrum consideration does not imply mutual interactions between elements so far. Thus, the applicability of analysis results has to be verified for each specific case. The analysis model is focused only to consideration of elements at the actual development status. However, variability can also occur in the probability of existence of dependencies. Future work will concern integration of dependencies in the presented approach. Moreover, effective methods of product spectrum restriction by means of exclusion dependencies and general constraints will be elaborated.

5 Conclusions

The known criteria for product structure analysis only allow research on fully specified product constellations. The new criteria of sensitivity enable the identification of important elements regarding their probable impact on entire product spectra. Thus, a multitude of possible products (not so far defined by their property specifications) can be optimized imposing little change effort for subsequent product customization.

The presented approach, which consists of a production system and methods of probabilistic reasoning, proves to be applicable to the use case. The simplified proceeding to determine the probability of existence of element constellations meets the low knowledge regarding dependencies in complex and unspecified product spectra.

The local sensitivity represents an effective assessment criterion, if a specific product space or constellations of a product spectrum must be analyzed. For a high significance at minimal effort, the considered space has to be systematically restricted. By applying the global sensitivity to a product spectrum, relevant information can be obtained, concerning the overall behavior of elements in question.

6 Acknowledgments

We would like to thank the DFG (Deutsche Forschungsgemeinschaft) for funding this project as part of the SFB 582, as well as our partners from the industry for good collaboration and extensive support.

References

- [1] Daenzer, W. F.: Systems Engineering. Zuerich: Verl. Industrielle Organisation 1999.
- [2] Ambrosi, S.: Methoden und Werkzeuge für die integrierte Produktentwicklung. Aachen: Shaker 1997.
- [3] Bernard, R.: Early Evaluation of Product Properties within the Integrated Product Development. Aachen: Shaker 1999.
- [4] Rich, E.: Artificial Intelligence. Singapore: McGraw-Hill 1985.
- [5] Maurer, M.; Lindemann, U.: Identification of Structural Characteristics in Product Spectra. In: Negoita, M. G.; Howlett, R. J.; Jain, L. C. (Eds.): Proceedings of the 8th International Conference, KES 2004 (Part 1), Wellington, New Zealand, September 20-25, 2004, Springer: Berlin 2004. pp. 1157-1163.
- [6] Maurer, M.; Pulm, U.; Lindemann, U.: Utilization of Graph Constellations for the Development of Customizable Product Spectra. In: Fourth International ICSC Symposium on Engineering of Intelligent Systems EIS 2004, Madeira, Portugal, 29.02 - 02.03.2004, ICSC Interdisciplinary Research Canada (CD-ROM).
- [7] Lindemann, U.; Pulm, U.: Enhanced Product Structuring and Evaluation of Product Properties for Mass Customization. In: HKUST; TUM (Eds.): MCP'01, World Congress on Mass Customization and Personalization, Hong Kong (China), 02.10.2001, (CD ROM).
- [8] Pahl, G.; Beitz, W.: Engineering Design. A Systematic Approach. London: Springer 1996.
- [9] Bertalanffy, L. v.: General System Theory. Foundations, Development, Applications. New York: George Braziller 1969.
- [10] Kusiak, A.: Computational Intelligence in Design and Manufacturing. New York: John Wiley & Sons 2000.
- [11] Pedersen, K.: Expert Systems Programming: Practical Techniques for Rule-Based Systems. New York: John Wiley 1989.

Maik Maurer
Technische Universität München,
Institute of Product Development
Boltzmannstr. 15
D-85748 Garching
Germany
Tel: +49 (0)89 289 15155
Fax: +49 (0)89 289 15144
E-mail: maurer@pe.mw.tum.de