

DESIGN FOR MICRO MILLING GUIDELINES

Pierre Vella, Jonathan C. Borg, Alexia K. Grech, David Spiteri, Jonathan Randich

Concurrent Engineering Research Unit
Department of Manufacturing, University of Malta

ABSTRACT

Miniaturisation of parts is emerging as an important approach to satisfy modern industrial and customer needs. Micro milling is one of the basic micromachining technologies used to produce miniaturised components. It differs from conventional machining in that the handling and machining of very small features generates various problems. As a consequence, designers need to consider such problems during design to make micromilling more feasible. More emphasis thus needs to be placed on deriving design know-how from the other product life-phases. This paper reports the work undertaken by the Department of Manufacturing within the University of Malta to generate a set of Design for Micromilling (DF μ M) guidelines that can contribute to the development to intelligent CAD for this domain.

Keywords: DFX, CAD, Providence, Micro products

1 INTRODUCTION

In the past, wristwatch parts were mainly the only products being manufactured which contained microparts/ features. Recent changes in society's demands coupled with advances in manufacturing methods have forced us to introduce more and more microparts/ features into various products. The advent of semiconductor devices has caused electrical circuits to become more compact. IC packages have micro dimensions. The circuit board must have microholes. Relays and switches are basically assemblies of micro-sized mechanical parts. Another example is the fuel injection nozzle in automobiles. Stringent environmental regulations has forced manufacturers to improve the nozzle design towards one of a smaller size and improved accuracy. Medical applications are also very important. Inspection and surgery with minimum invasion in the body so as to minimise pain/ discomfort are required. The miniaturisation of medical tooling is one of the effective approaches to achieve this. Mechanical micromachining is one of the key technologies that can enable the realisation of all the above [1].

Mechanical micromachining technologies are tool-based technologies which derive from miniaturisation of conventional manufacturing processes, such as subtractive machining. One such important micromachining process is micromilling. Its benefits include the ability to fabricate *micro-scale* parts out of a great range of materials, with more varied and intricate geometry. It mainly deals with the manufacture of parts whose 'form features' (e.g. slots and protrusions) or one of their dimensions is in the order of μm [2].

2 INDUSTRIAL PROBLEM BACKGROUND

Fabricating miniature parts means that micro-scale features such as very small holes and slots, have to be milled either on the part itself or for certain fabrication processes such as spark erosion, to generate the right tooling e.g. electrodes. This presents a number of challenges

such as the proper fixturing of small components and the clamping of very small cutters in tool holders, as seen in Figure 1.

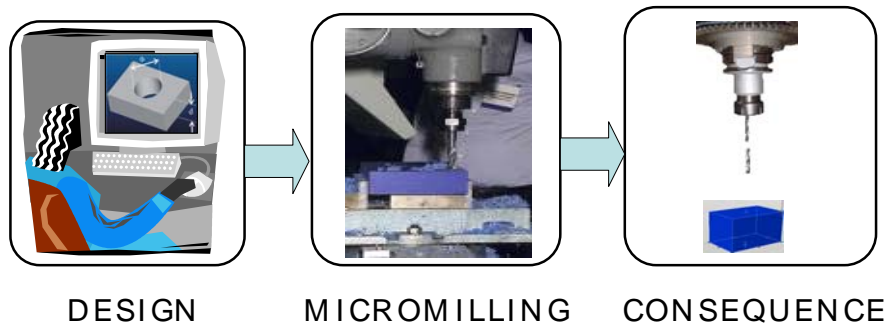

Figure 1. Challenges in fabricating miniature parts

At the same time despite the increasing use of micromilling, a literature survey indicates that design methodology [3] in this domain is still in its infancy and that there is a shortage of relevant *DFX guidelines*. Given that design decisions are known to have a *dispositional effect* [4] on the other life phases including manufacturing, this collectively indicates a need to provide guideline support to help designers commit decisions that result in parts suitably designed for micro-milling operations. It is however not enough to reveal and control the designer's dispositions – rather there is a need to have a wider insight into the interactions between the different life-cycle phases. Consequently, designers need to ideally adopt a Design For Multi-X (DFΣX) approach [5]. Therefore, DFX-type knowledge should be available and employed as from the conceptual design stage. Furthermore, if DFμM knowledge is captured and codified in a *Knowledge Intensive CAD (KICAD)* tool, then relevant life-cycle consequences (LCCs) [5] could be explicitly revealed to guide designers in generating solutions suitable for micromilling. Thus the overall aim of this research therefore is to generate and evaluate the effectiveness of '*Design for Micromilling*' guidelines which can eventually be employed in a KICAD tool aimed at explicitly helping designers generate both microparts/features and related tooling solutions

A brief outline of each section of this paper is now presented. Section 3 critically reviews the state-of-the-art on Design for Micromilling (DFμM) Guidelines. Based on the problem identified in this section, the goal and boundary of this research are also formulated. Section 4 then discloses the research approach adopted. Section 5 then describes the set of machining experiments designed as a basis for generating appropriate DFμM guidelines. Subsequently Section 6 discloses the structuring of the DFμM guidelines and a sample set of DFμM guidelines is generated. An explanation of how these guidelines were implemented in a computational tool, for evaluation purposes, is given in Section 7. Section 8 presents the results emerging from this evaluation and a final conclusion is made in Section 9.

3 STATE-OF-THE-ART FOR DFμM SUPPORT

Within established domains of micro technology such as microelectronics, silicon machining or LIGA, past production expertise is being captured as design rules to provide a means by which to improve the generation of suitable design solutions in the design stage [6],[7],[8],[9],[10],[11], as cited by Albers in [12]. A literature review on the domain of mechanical micromachining technologies has revealed that there is indeed little if any work explicitly related to the generation of DFμM guidelines. Relevant work in this area is being carried out by Albers et al in [3] who have proposed design rules as an aid supporting the process of the product design of primary shaped¹ micro components from metallic and ceramic materials with a high load carrying capability. The design rules by Albers et al cover

¹ Primary shaping – e.g. Injection molding

various processes including micro-milling. Furthermore, the rules generated are organized in a classification. Although this classification is a very important step in the right direction to help with the retrieval of the ‘right DF μ M guideline’ at ‘the right time’, one should note that the classification proposed by Albers et al is production technology-based rather than a part feature-based classification. As designers typically generate micro-scale design solutions in terms of part features rather than processes used to create such microfeatures, then the classification proposed limits the effective support it can provide to designers whilst generating solutions. Furthermore, as the guideline format is production technology-based, design exploration becomes hindered as it assumes a pre-determined production technique. The lack of documented DF μ M guidelines itself implicitly indicates why, proactive computational support to help design micro-scale parts and features is basically not available. Thus, the state-of-the art currently indicates that (i) there is a lack of documented DF μ M guidelines (ii) there is a need to generate a taxonomy of micro-scale form features to support efficient DF μ M knowledge structuring and reuse (iii) Knowledge Intensive CAD tools that proactively support designers are missing.

4 RESEARCH APPROACH

Given the above background and state of the art, in order to carry out scientific research to contribute a solution to the gap identified in section 2 above, the following approach as shown in Figure 2 below has been systematically adopted.

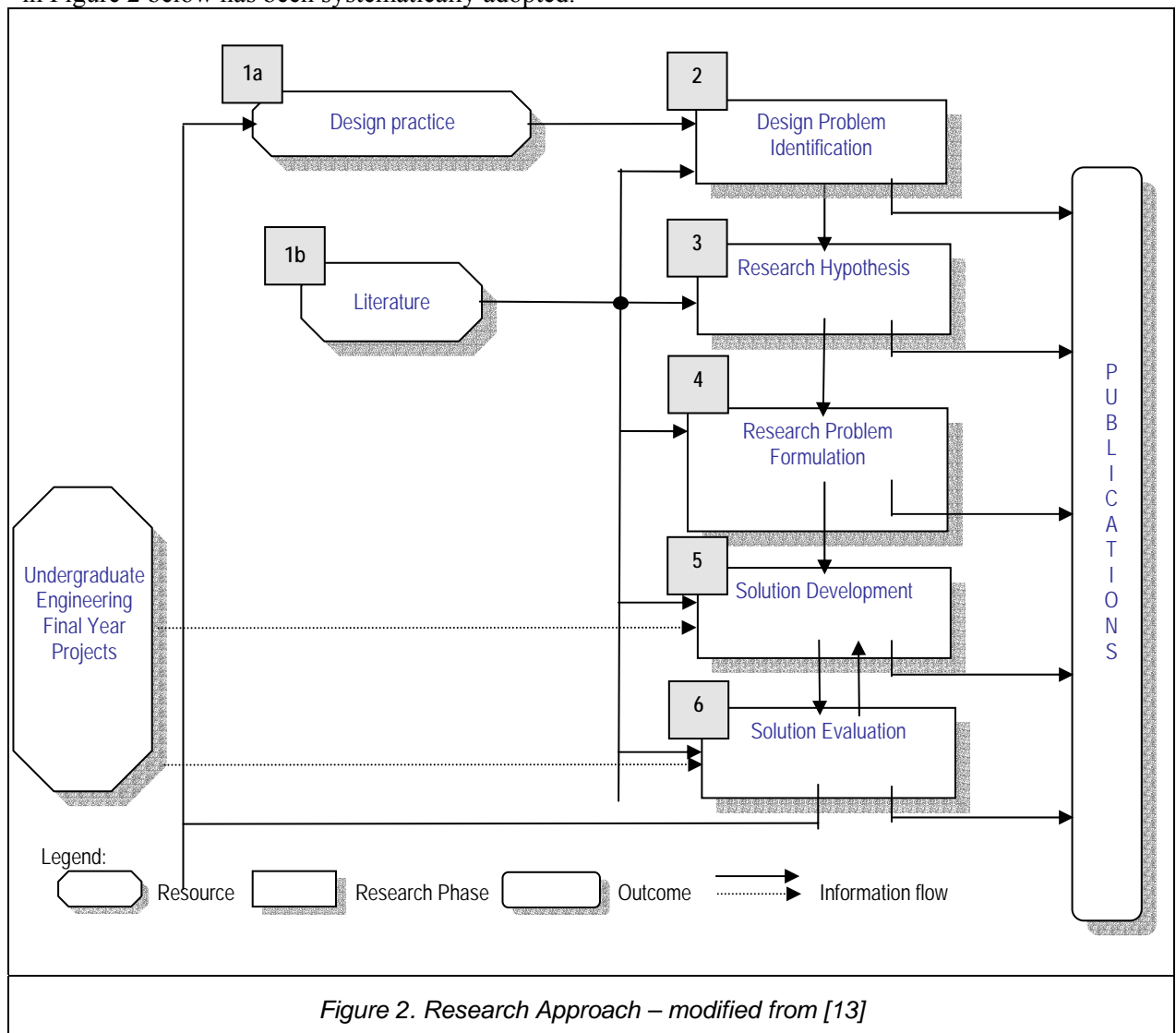

Figure 2. Research Approach – modified from [13]

As highlighted in Section 2.0 – Industrial Problem Background, in industrial product development practice, micromilling presents a number of challenges such as the proper fixturing of small components, clamping of very small cutters in tool holders, machining strategy to be utilised etc. As a consequence, designers need to consider such problems during design to make micro-milling more feasible. Thus product development practice in industry (1a) together with a literature search (1b) as highlighted in Section 3 –State-of-the-art for DF μ M Support, provided a foundation for characterizing the design problem (2).

This basically is that designers lack design for Micromilling knowledge and that there is a lack of DF μ M guidelines which can eventually be employed in a KICAD tool. A basic hypothesis (3) for a solution to the identified problem was generated – namely that if designers are provided with Design for Micromilling Guideline support, this would enable designers commit decisions that result in parts that are suitable for micromilling. This gave rise to the research problem (4) – that of generating and evaluating the effectiveness of ‘*Design for Micromilling*’ guidelines which can eventually be eventually employed in a KICAD tool aimed at explicitly helping designers generate both micro-parts/features and related tooling solutions. On tackling the research problem, a solution (5) was arrived at. The solution development stage consisted of the following steps - Designing, setting up & executing a series of machining experiments; Identifying how Design for Micromilling knowledge can be structured in the most appropriate way to guide the engineering designer; Selecting the DF μ M indexing scheme, Selecting the appropriate feature taxonomy to be adopted for 2D, 2 1/2D & 3D features, Extracting relevant data/ results from production related knowledge and structuring it into appropriate prototype design for micromilling guidelines. To test the effectiveness of the solution, a prototype design for micromilling guidelines in Hypermedia was implemented. This provided a basis for critical evaluation (6) of the result, enabling the identification of the strengths and weaknesses of the solution, and thus the identification of future research directions. Information extracted from a number of student projects [14], [15] was also utilised as an additional input to the different phases in the methodology. Finally the elements in the methodology collectively contributed to the generation of this paper.

5 MACHINING EXPERIMENTS

As a first step, relevant data on the production equipment and the respective cutters to be used were collated. This was done in order to systematically collect equipment & tooling characteristics such as machine spindle speeds, individual tooling geometrical dimensions and materials, etc. A series of machining experiments involving 2D, 2½D and 3D parts were designed and executed in order to systematically relate design decisions made concerning various micro part design parameters (e.g. material, feature dimensions) and the resulting constraints/ variable parameters on the micro-milling process. The two main issues to successfully machine features/parts at “micro” scale are the following:

- The depth of cut, spindle speed and the feed rates should be chosen depending on the workpiece material, cutting tool material & geometry.
- The machining strategy (e.g. step over movements, avoiding sharp changes in cutting direction, use of cutting fluid/air/oil mist, etc.) should be selected by taking into account the specific geometry of the component.

These process parameters affect directly or indirectly the accuracy and surface quality of the micro features/ parts. Various sample 2D, 2½D & 3D geometries were machined using the appropriate micro-milling cutters/drills in order to cover a wide range of possible features. The features were tested on 3 material types Acrylic Perspex (plastic), Aluminium (non-ferrous), Bright mild steel (ferrous). Design of Experiments methods were used so that only a fraction of the full-factorial combinations were tested due to time limitations and machining cost. Design of experiment calculations and graph plotting was carried out using an

appropriate software package available in-house for the various combinations of workpiece materials, cutter types and sizes and geometric features. The dimensions and surface finishes of the features were measured and the results of the dimensional accuracies and surface roughness for each feature on each material were plotted on graphs. The graphs generated indicated the optimum parameters for each experimental run.

6 SOLUTION DEVELOPMENT

6.1 Structuring of DF μ M Guidelines

DF μ M Knowledge structuring concerns two main issues:

- a) individual DF μ M guideline format
- b) Indexing of all DF μ M guidelines generated for supporting retrieval with ease of the right guideline at the right time in a specific design scenario.

6.1.1 DF μ M Guideline Format

The chunks of knowledge resulting from the machining experiments' had to be structured into appropriate '*Design for Micro-Milling*' guidelines, a sample of which will be presented in the following sections. As acknowledged in literature [16] decisions made during design result in consequences (e.g. problems with micromilling). Nowack explains that a *consequence* is produced by an *action* chosen by a designer trying to resolve an *issue*. The resulting consequence is then used to check if it fulfils the issue being addressed. The method thus employed for DF μ M knowledge structuring is thus based on the 'action-centred design model of Nowack. Thus, the micromilling/ drilling knowledge was represented using rules in the form shown in Figure 3 below. Each rule stated, describes the parameters or variables which *condition* the affect on the design. The condition will be justified by generating any possible *problems* or *opportunities* which will be encountered throughout the product life-cycle phases.

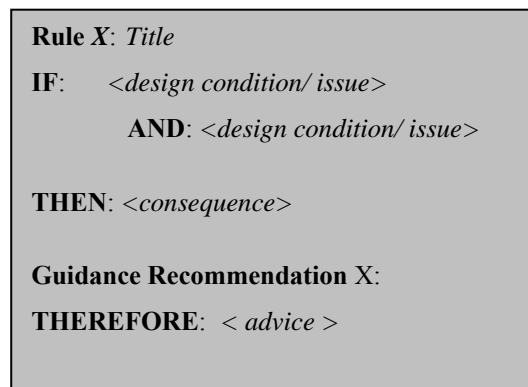

Figure 3. Format of DF μ M Guidelines

Recommendations will aid/guide the designer to overcome the problems which propagate an influence on *time*, *cost* and *quality* measures of the products.

6.1.2 Guideline Feature Taxonomy

Taxonomies represent a basis on how the guidelines will be classified so the designer can retrieve the right guidelines for the design in hand. In micromilling it is necessary to classify a micro feature into three main groups - namely 2D, 2½D & 3D. A number of taxonomies have been created and the most suitable depends on the situation in question. Various 2½D

taxonomies were reviewed including Pratt and Wilson's [17], Butterfield's [18] and Gindy's [19] Feature Taxonomies. Gindy's taxonomy was considered to be the most suitable. Gindy's Taxonomy is ideal to represent 2½D features in the micromilling. This is because, in this taxonomy, features are characterized by the number of orthogonal directions from which the feature volume might be approached [19]. These are known as *External Access Directions* (EADs) all features will have between 0 and 6 EADs. The EADs can also be considered as the possible directions from which the feature can be manufactured. On the other hand, for 3D feature taxonomies, Cheuetet [20] proposed a classification which is shape oriented in order to satisfy the designers needs for rapidly accessing any possible 3D feature. This taxonomy is organized in three levels. The first two levels are classified according to external properties characterizing the shape in accordance with the surface. Level 0 is considered as the morphological characterization which distinguishes bumps (protrusions), hollows (depressions) and features mixing these two different types. Level 1 is considered as the topological characterization level which distinguished channel, border and internal features. The third level (Level 2) classifies the features according to internal properties, defining the behaviours of the surface in the area where the feature is inserted.

6.1.3 DFµM Guideline Indexing

These guidelines are represented by a code in the form of which are based on the format of Albers et al [3]. Essentially the main difference being proposed is to substitute the guideline consecutive number with a guideline code as follows:

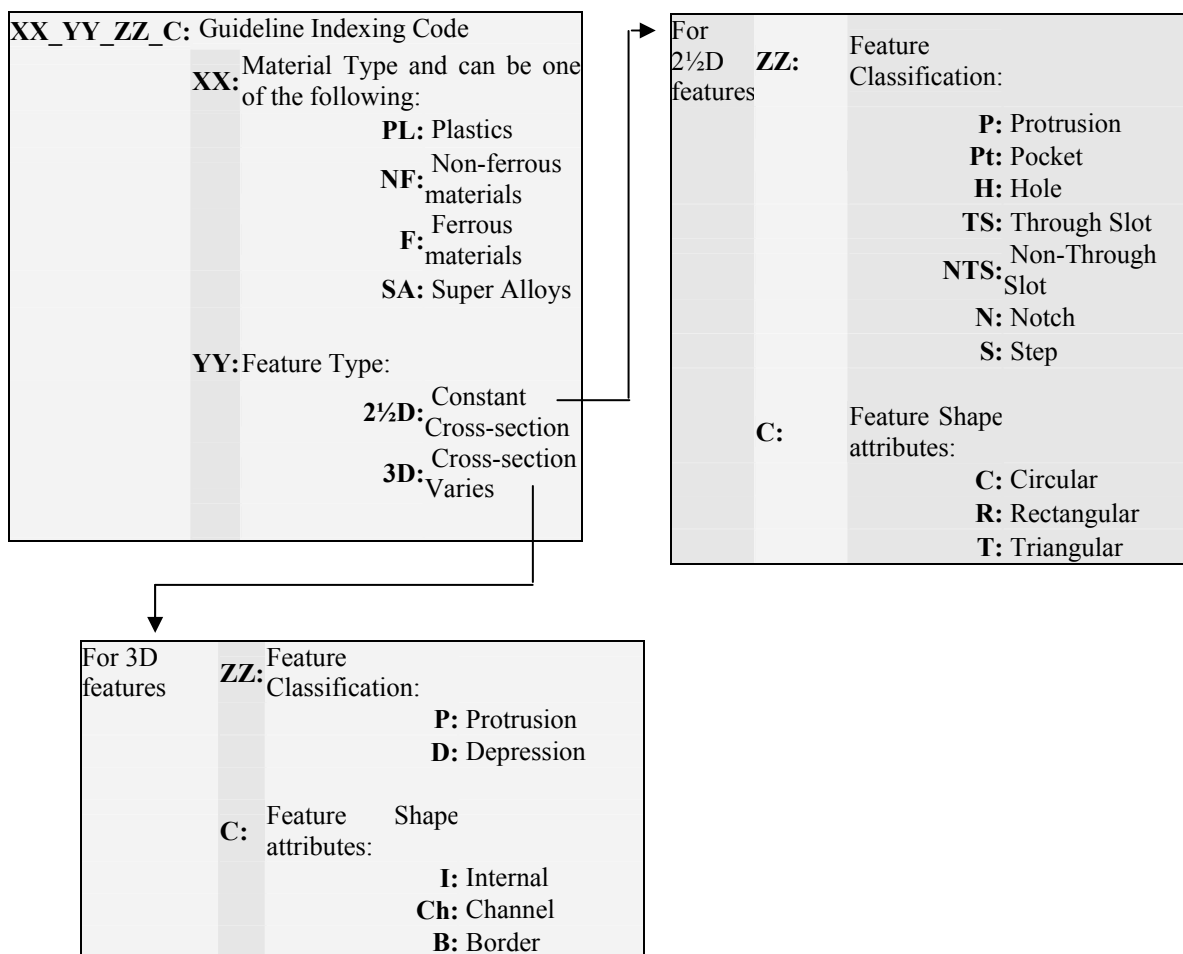

Figure 4. Guideline Indexing

Example:

PL_3D_D_I: Plastic 3D Internal Depression Feature

PL_2½D_P_C: Plastic 2½D Circular Protrusion Feature

Thus, the guideline indexing code is used to provide identification of the feature and materials concerned.

6.2 Typical DFμM Guideline

The notation below proposed by Borg et al [21] will be used to give an example of a DFμM Guideline in the format shown in Figure 5.

[a] = 'a' is an element that can be directly defined by the designer;

For example [material]

[a] = 'a' is a class;

For example [ferrous materials]

$a \wedge b$ = 'a' and 'b' (conjunction)

$a \vee b$ = 'a' or 'b' (disjunction)

[F] = Form Feature, for example *hole*

Where $[F_{2\frac{1}{2}D}]$ = 2½D form feature (*refer to Gindy's Taxonomy*)

$[F_{3D}]$ = 3D form feature (*refer to Cheutet's taxonomy*)

$[F]_a$ = 'a' is a feature parameter

For example $[F]_h$ = height of the feature

[M] = Component Material, for example aluminium

{O} = a set of options for 'O'

For example $\{[F] = \text{Hole} \vee \text{Slot}\}$; is the form feature a hole or a slot

The following illustrates a typical DFμM Guideline:

Rule 1: Minimum diameter: Slender ratio (Φ/d)

IF: $[F] = \{ [F_{2\frac{1}{2}D}] = \text{Hole} \}$
 $\vee \{ [F_{3D}] = \text{Internal Depression} \}$

AND: $[F]_\Phi < 1\text{mm}$

AND: $[M] = \text{Perspex} \vee \text{Aluminium} \vee \text{Mild Steel}$

AND $\{ ([F]_{\Phi/d})_{\text{perspex}} < \frac{1}{3} \vee ([F]_{\Phi/d})_{\text{aluminium}} < \frac{1}{2.5} \vee ([F]_{\Phi/d})_{\text{mild steel}} < \frac{1}{2} \}$

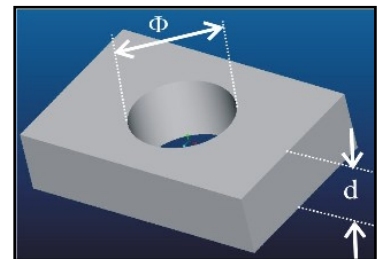

Figure 5 . Slender ratio of through hole

THEN: Problems during:

Design: Due to incorrect parameters and at the expense of time and money, the feature will have to be re-designed due to restrictions in manufacturing.

Manufacturing

The slender ratio can easily affect the dimensional accuracy of the feature. Due to the forces involved in the cutting process the smaller the slender ratio the higher the possibility for the cutter to bend. This bending causes an

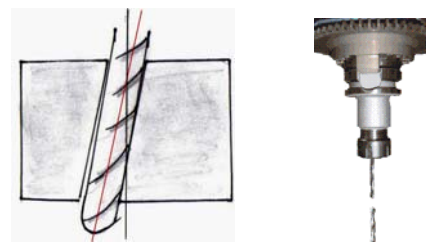

Figure 6. Hole eccentricity and Tool breakage

eccentric movement of the tool. As the tool gets deeper it will continue bending causing feature eccentricity and can also break easily, as shown in Figure 6.

Assembly: Due to flaws in manufacturing, the feature would be out of specification and can be impossible to assemble with its mating feature.

Guidance Recommendation 1:

THEREFORE: Possible solutions:

1. Increase diameter
2. Decrease height
3. Use alternative material with better machinability.

7 SOLUTION EVALUATION

As a preliminary proof of concept, a prototype system has been implemented in a hypermedia based system. Hypermedia was used because it is possible to browse through various areas freely and with relative ease, and it permits multiple users to make use of the system and retrieve the appropriate guidelines simultaneously.

The system has been organised in a specific manner to retrieve the appropriate guidelines for the designer. During design, as shown in Figure 7, the designer can interact with the system by first selecting the material (step 1), after which a list of features can be selected which are organised in 2½D (according to Gindy’s Taxonomy), and 3D (according to Cheutet’s Taxonomy) taxonomies (step 2 & 3). A list of parameters (step 4) specific for each feature is listed. The designer is then shown the overall effect on the product life cycle due to these certain feature parameters. The detailed consequences (step 5) brought about due to the design decision will provide awareness to the designer who can then avoid the consequences using alternative solutions which are recommended by the system (step 6). The recommendations may be either in the form of changing various design commitments (material or feature type) or by modifying the parameter values. A typical screen dump of how a guideline is provided to the designer is shown in Figure 8 hereunder.

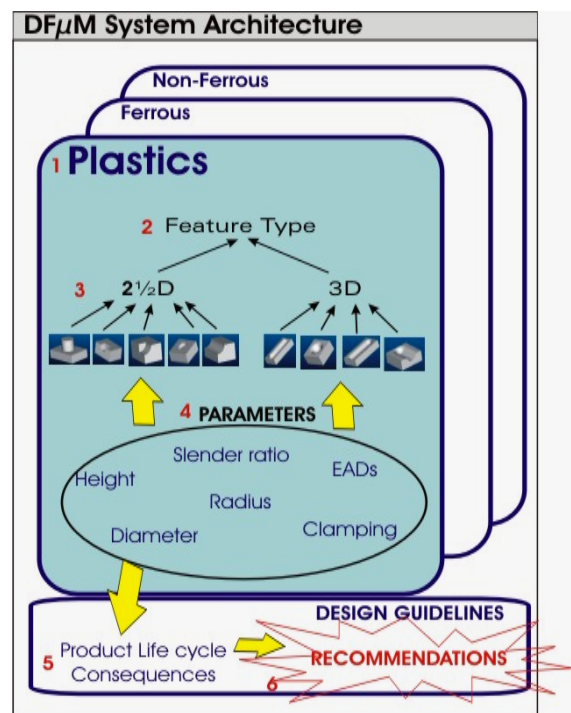

Figure 7. Proposed DFμM system architecture

8 PRELIMINARY EVALUATION RESULTS

Before investing further research effort in the further development of DFμM, a preliminary evaluation of the implemented proof-of-concept DFμM system has been performed. This consisted of a preliminary evaluation of the effectiveness of the support provided by the

Feature Parameters

Feature Illustration showing main parameters

Overall Life cycle effect

Links to detailed explanation

Border Depression		
PARAMETER	GEOMETRIC CLASS	GEOMETRIC NUMBER
	DR, JHT3	HF, 3D, D, B
Parameters	Conditions	Overall Effect
Height 'H'	H < 2mm	✓
	H > 2mm	✗
Concave Radius 'R'	R > 0.2mm	✓
	R < 0.2mm	✗
Convex Radius 'r'	r = 0mm	✗
External Access Directions (EADs)	EADs = 1	✗

STEP 4

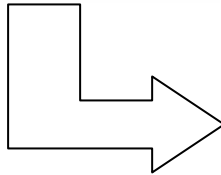

CONSEQUENCES	
DESIGN	The feature will have to be re-designed due to restrictions in manufacturing.
MANUFACTURE	While the tool is cutting the material the shank of the tool will be in contact with the workpiece. The interference caused can result in tool breakage or damage to the work piece. Tool breakage/damage to the workpiece can be costly as follows: <ol style="list-style-type: none"> 1. The cost of machine idle time to replace the tool. 2. The cost of providing a new tool. 3. Cost to align & machine new workpiece
ASSEMBLY	This contact will also affect the dimensional accuracy and surface roughness of the feature. If the feature is a mating feature it might be difficult or even impossible during the assembly procedure. These inaccuracies might require further finishing operations, always at the expense of time and money.
USE	Due to inaccuracies there can be a certain amount of <i>play</i> in the product. This <i>play</i> diminishes the quality of the product and can reduce the life time of the product during use.

STEP 5

DESIGN GUIDELINE
Non-Ferrous
Type of Feature
Feature Library
View Tutorial
RECOMMENDATIONS

RECOMMENDATIONS
Decrease Height 'H'
Ensure that the height of the feature is less than the cut length of the available cutters. Therefore in most cases: H < 2mm.
Increase radius 'R'
This will avoid any contact of the tool with the workpiece. Machining time will increase to create the feature with a larger surface area to cut.
Use other clearances
Make use of various types of clearances which will require additional machining processes.

STEP 6

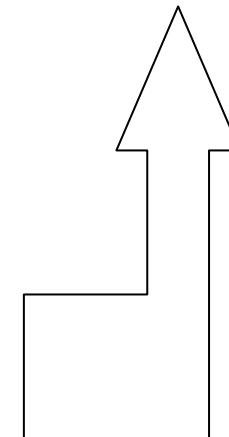

Figure 8. Typical guideline

knowledge captured within the DF μ M prototype. This has been performed with a sample of 4 users (3 research engineers and 1 engineer). This evaluation consisted of the users going through a micro part design scenario supported by the DF μ M system. The design of a high speed, air-driven, aluminium rotor having micro features was used. The rotor chosen is an essential component in a dental handpiece used for drilling and grinding in dental surgery. Following this design scenario, the evaluators were taken through a structured interview to establish the level of support they felt they had received during the design session. Evaluation with practising designers which is a necessity for an insight into the practical application of DF μ M still has to take place. Key results of the evaluation performed are depicted in Table 1 below.

Table 1. Preliminary Evaluation Results

Evaluation Criteria	Rating					Key
	1	2	3	4	5	
Understandable guidelines				✓✓✓	✓	5 Very Good
Appropriate to specific design			✓	✓✓	✓	4 Good
Awareness of micromilling LCCs				✓✓	✓✓	3 Sufficient
Retrieve ability of the guidelines			✓✓	✓✓		2 Needs Improvement
Rapid Exploration of the system		✓✓✓	✓			1 Insufficient
High Level of Detail in knowledge given			✓✓✓	✓		

9 CONCLUSIONS

The evaluation carried out, reveals both strengths and weaknesses. From the strengths point of view, the evaluators, in general, believed that the system was structured in an appropriate way and found the library of features very useful to retrieve the appropriate guidelines. The diagrams were considered to be self-explanatory and gave “ample explanations” as they helped the designer visualise and understand the limitations brought about by the micro-milling operation. In addition, this awareness motivated them to reconsider their part design decision commitments so as to reduce/avoid bad consequences. Furthermore, in the cases that problems were likely to be encountered during the realisation of the component, DF μ M provided the designer with possible corrective actions that could be taken in order to avoid such problems. On the other hand the evaluators believed that the system needed to be improved in terms of interactivity on the whole, as in some instances it was found difficult to navigate through the guidelines. Two also indicated that the support provided would be enhanced if they are *proactively* guided on how to re-design their part to avoid certain micro-milling problems. Future work is thus needed, in particular for practical purposes; primarily there is a need to generate a larger number of guidelines. Secondly, from a design support tool perspective, the DF μ M system is currently separate from the evolving part design solution. Thus, for effective proactive design support, the guidelines should be embedded within a KICAD system that will proactively guide designers in generating micro-scale parts and features. Thirdly, the guidelines embedded within a KICAD system should be evaluated with practising designers which is a necessity for an insight into the practical application of DF μ M. Nevertheless, the work reported in this paper contributes a step forward towards the generation of well structured DF μ M guidelines for eventual intelligent CAD implementation.

REFERENCES

- [1] Masuzawa T. State of the Art of Micromachining. In *Annals of the CIRP*, vol. 49 no. 2., 2000, pp. 473-488.
- [2] Alting L. Kimura F. Hansen H.N. and Bissacco G. Micro Engineering. In *Annals of the CIRP*, vol. 52, no. 2, Sept 2003, pp. 635-637.
- [3] Albers A. Marz J. and Bukhardt N. Design Methodology in Micro Technology. In *International Conference on Engineering Design, ICED 03*, Stockholm, August, 2003.
- [4] Olesen J. *Concurrent Development in Manufacturing – based on dispositional mechanisms*. PhD, Institute for Engineering Design, Lyngby, The Technical University of Denmark, 1992.
- [5] Borg J. and MacCallum K.J., Structuring Knowledge of Life-Cycle Consequence for Supporting Concurrent Design Exploration. In *Proceedings, IFIP WG5.2 Knowledge Intensive CAD*, Pittsburgh, PA, USA, 1996, pp 208-213.
- [6] Mead C. and Conway L. *Introduction to VLSI Systems*, 1980 (Addison Wesley).
- [7] Leßmöllmann C. *Fertigungsgerechte Gestaltung von Mikrostrukturen für die LIGA-Technik*. PhD, University of Karlsruhe (TH), Germany, 1992.
- [8] Scherer K.P. Buchberger P. Eggert H. Stiller P. and Stucky U. Knowledge based support for manufacturing of microstructures. *Microsystems Technology*, 1996, (2), 167-170.
- [9] Hansen U. Germer C. Büttgenbach S. and Franke H.J. (2002) Rule based validation of processing sequences. In *Proceedings of the 5th International Conference on Modelling and Simulation of Microsystems*, 2002.
- [10] Rabaey J.M. Chandrakasan A. and Nikolic B. (2003) *Digital Integrated Circuits – A Design Perspective*, 2nd.ed, 2003 (Prentice Hall, New Jersey).
- [11] Solf C. Janssen A. Mohr J. Ruzzu A. and Wallrabe U. (2003) *Incorporating Design Rules into the LIGA Technology applied to a Fourier Transformation Spectrometer*. Book of Abstracts HARMST 03.
- [12] Albers A. Burkardt N. Deigendesch T. and Marz J. Micro-specific design flow for tool-based microtechnologies. *Microsystems Technology*, 2007, 13, 305-310.
- [13] Duffy, A. H. B. & O'Donnell, F. J. (1998) "A Design Research Approach", *Workshop on Research Methods in Artificial Intelligence in Design (AID'98)*, Lisbon, Portugal, pp. 20-27.
- [14] Spiteri D. *Towards Micro Milling Guidelines*, B.Eng. dissertation, University of Malta, Malta, May 2005.
- [15] Randich J. *Investigation in Machining of Miniature Components on a CNC Vertical Machining Centre – A Feasibility Study*, B.Eng. dissertation, University of Malta, Malta, May 2004.
- [16] Nowack M.L. *Design Guideline Support For Manufacturability*. PhD, Engineering Department, Cambridge University (UK), 1997.

- [17] Pratt M.J., Wilson P.R., *Requirements for support of form features in a solid modelling system*. Technical Report R-85-ASPP-01, CAM-I, 1985.
- [18] Butterfield W. Green M. Scott D. and Stoker W. Part features for process planning. Technical Report R-86-PPP-01, CAMI, November 1986.
- [19] Casey K. and Wan Harunz W.A. Feature-based representation for manufacturing planning. *Int. J. Prod. Res.*, 2000, 38(17), 4285 – 4300.
- [20] Cheutet V. Catalano C.E. Pernot J.P. Falcidieno B. Giannini F. and Leon J.C. 3D Sketching with Fully Free Form Deformation Features for Aesthetic Design. In *EUROGRAPHICS Workshop on Sketch-Based Interfaces and Modeling*, 2004, pp. 13.
- [21] Borg J.C. Yan X.T. Juster N. P. Guiding component form design using decision consequence knowledge support. *Artificial Intelligence for Engineering Design, Analysis and Manufacturing*, 1999, 13, 392–393.

Contact: Ing. Pierre Vella
University of Malta
Department of Manufacturing
Faculty of Engineering
MSD 06, Msida
Malta
(+356) 2340 2366
(+356) 21 343577
pvella@eng.um.edu.mt